

Link

Gruppo Fox Design

Caratteristiche Features



- Rivestimenti in tessuto completamente sfoderabili. Profili in tessuto in tinta o in contrasto.
Fully removable fabric covers. Profiles in matching or contrasting fabric.
- Cuscini schienale in vera piuma, con inserto in espanso morbido, ricoperti in tessuto di puro cotone a tenuta di piuma.
Back cushions in real feather, with insert in soft foam, covered in feather-tight pure cotton fabric.
- Struttura in multistrato e derivati legno, rivestita in poliuretano espanso, il tutto rivestito in vellutino.
Structure in plywood and wood derivatives, covered in polyurethane foam, all covered in velvet.
- Cuscini seduta in poliuretano espanso a quote differenziate rivestito con un trapuntino in vera piuma, il tutto ricoperto di puro cotone a tenuta di piuma.
Seat cushions in differentiated-density polyurethane foam covered with a real feather quilt, all covered in pure feather-tight cotton.
- Piedi a vista conici (diametro da mm 30 a mm 15) in fusione di alluminio nella finitura lucida o verniciata bronzo.
Conical visible feet (diameter from 30 mm to 15 mm) in cast aluminum in polished or bronze painted finish.

Variazioni Variations



PIEDI CONICI IN FUSIONE DI ALLUMINIO
CONICAL CAST ALUMINUM FEET



PIEDI CILINDRICI IN ACCIAIO
CYLINDRICAL STEEL FEET

A richiesta sono disponibili piedi a vista cilindrici (diametro mm 20) in acciaio disponibili nella finitura cromata lucida o verniciata bronzo. Si prega di specificare le finiture al momento dell'ordine.

Upon request cylindrical exposed feet (diameter 20 mm) in steel are available in polished chrome or bronze painted finish. Please specify finishings upon order.



A richiesta e con una maggiorazione, viene eseguita solo per le pelli una particolare cucitura con finitura "taglio a vivo". Si prega di specificare le finiture al momento dell'ordine.

Upon request and with a price increase, it is carried out only for leathers a particular stitching with "raw cut" finish. Please specify the finishes when ordering.

Profili in tessuto in tinta o in contrasto. Su richiesta e senza maggiorazione è possibile ordinare il divano senza i profili sulla cuscineria di seduta. Si prega di specificare le finiture al momento dell'ordine.

Le imbottiture in piuma conferiranno al divano un aspetto più destrutturato e vissuto, le forme dei cuscini diverranno quindi più morbide.

Profiles in matching or contrasting fabric. Upon request, and with no price increase, it is possible to order the sofa without sewn profiles on seat cushions. Please specify finishings upon order.

The feather padding will give the sofa a more unstructured and worn look, the shapes of the cushions will therefore become softer.

Elementi Elements

LINCD172

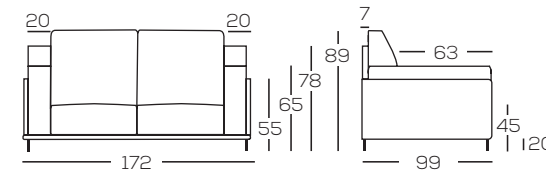

LINCD192

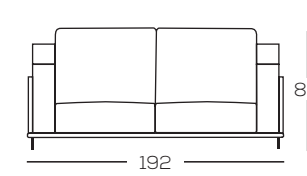

LINCD212

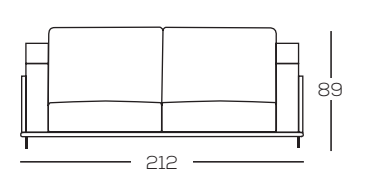

LINCD232

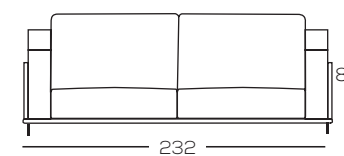

LINCD252

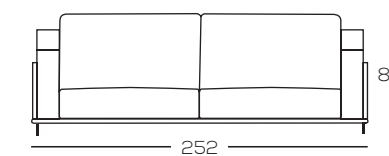

LINCT152 Dx/Sx

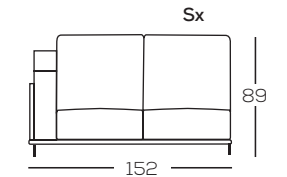

LINCT172 Dx/Sx

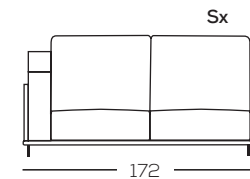

LINCT192 Dx/Sx

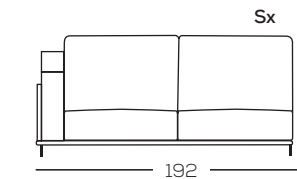

LINCT212 Dx/Sx

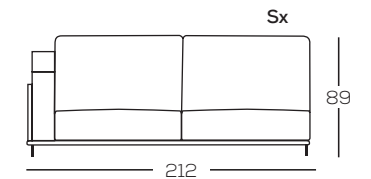

LINCT232 Dx/Sx

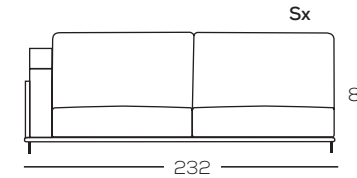

LINCR170 Dx/Sx

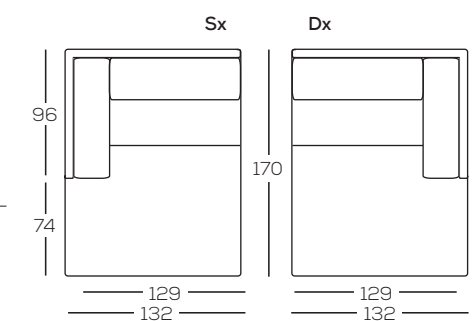

LINCR180 Dx/Sx

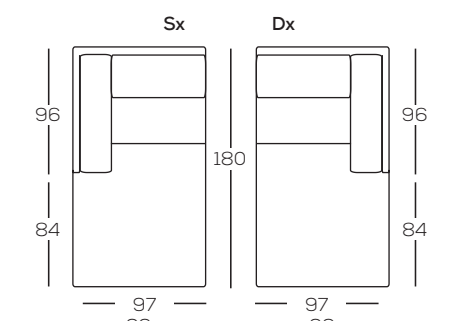

LINCPF70

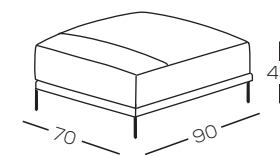

LINCPF100

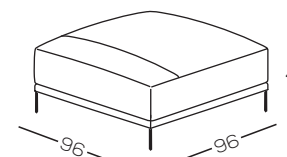

LINCTA243 Dx/Sx

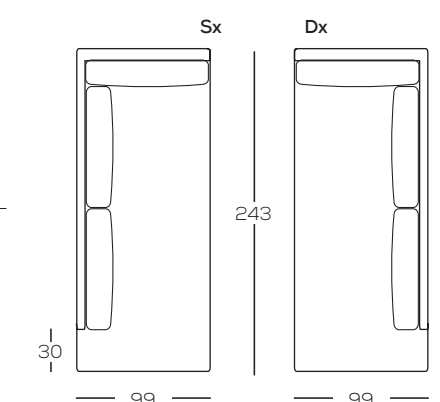

LINCCS50

